

High Bay Ufo

5 anos
GARANTIA



Equivalência	
HIGH BAY UFO	VAPOR METÁLICO
100W	150W
150W	250W
200W	400W

Mais econômica e eficiente

Aplicações



INDÚSTRIA



AEROPORTO



DEPÓSITO E GALPÃO

A linha de produtos Pro da Avant é direcionada para os profissionais que necessitam de soluções personalizadas para o mercado industrial, comercial e corporativo.

A luminária High Bay Ufo é a opção ideal para projetos que exijam uma solução de iluminação robusta e com o máximo de desempenho. A linha conta com opções de 100W, 150W e 200W, todas com alta eficiência luminosa de 150lm/W.

Tipo de instalação (suporte):
Gancho aberto

Corpo em alumínio fundido, lente em policarbonato

● Cor Preta



TENSÃO



NÃO DIMERIZÁVEL



IRC



USO INTERNO E EXTERNO



FÁCIL INSTALAÇÃO

AVANT
PRO

Especificações técnicas e comerciais

CÓDIGO	DESCRIÇÃO COMERCIAL	POTÊNCIA (W)	FLUXO LUMINOSO (lm)	EFICIÊNCIA LUMINOSA (lm/W)	ÂNGULO DE ABERTURA (°)	FATOR DE POTÊNCIA	CORRENTE NOMINAL (mA)		PESO (g)	TEMPERATURA DE COR	DIMENSÕES (mm)		
							127 V	220 V			A	B	
495010878	LED-HIGH-BAY-UFO-90-NE4000K-100W-BIVOLT-15000	100	15.000	150	90	> 0,92	856	494	2.100	NEUTRA 4000K	Ø270	165	
495021379	LED-HIGH-BAY-UFO-90-BR6500K-100W-BIVOLT-15000						856	494		BRANCA 6500K			
495030876	LED-HIGH-BAY-UFO-90-NE4000K-150W-BIVOLT-22500	150	22.500				1.284	741	2.400	NEUTRA 4000K	Ø310	170	
495041377	LED-HIGH-BAY-UFO-90-BR6500K-150W-BIVOLT-22500						1.284	741		BRANCA 6500K			
495050874	LED-HIGH-BAY-UFO-90-NE4000K-200W-BIVOLT-30000	200	30.000				1.712	988	2.900	NEUTRA 4000K	Ø360	170	
495061375	LED-HIGH-BAY-UFO-90-BR6500K-200W-BIVOLT-30000						1.712	988		BRANCA 6500K			
495070872	LED-HIGH-BAY-UFO-120-NE4000K-100W-BIVOLT-15000	100	15.000		120		90	856	494	2.100	NEUTRA 4000K	Ø270	165
495081373	LED-HIGH-BAY-UFO-120-BR6500K-100W-BIVOLT-15000							856	494		BRANCA 6500K		
495090870	LED-HIGH-BAY-UFO-120-NE4000K-150W-BIVOLT-22500	150	22.500				1.284	741	2.400	NEUTRA 4000K	Ø310	170	
495101378	LED-HIGH-BAY-UFO-120-BR6500K-150W-BIVOLT-22500						1.284	741		BRANCA 6500K			
495110875	LED-HIGH-BAY-UFO-120-NE4000K-200W-BIVOLT-30000	200	30.000				1.712	988	2.900	NEUTRA 4000K	Ø360	170	
495121376	LED-HIGH-BAY-UFO-120-BR6500K-200W-BIVOLT-30000						1.712	988		BRANCA 6500K			

Temperatura de Operação: 20° a 70°

Temperatura Ambiente: -35° a 45°

Modelo



Dimensões

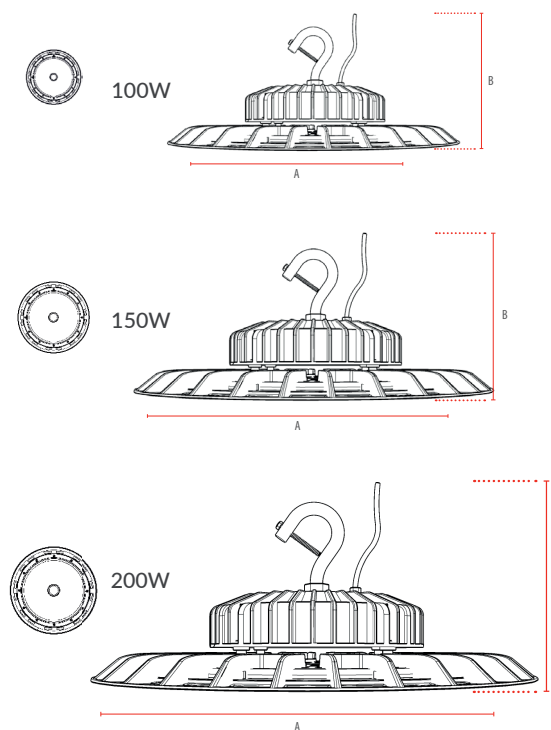

Curva de distribuição da intensidade luminosa-Versão 90°

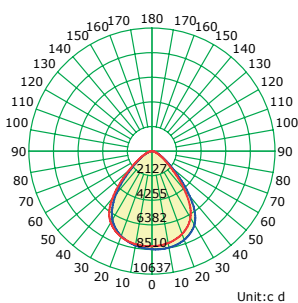

— C0-C180 — C90-C270

Potência 100W | 127V - 220V

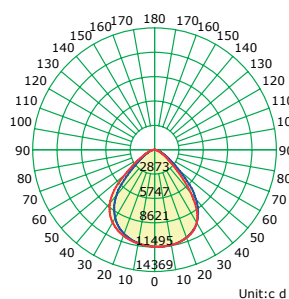

— C0-C180 — C90-C270

Potência 150W | 127V - 220V

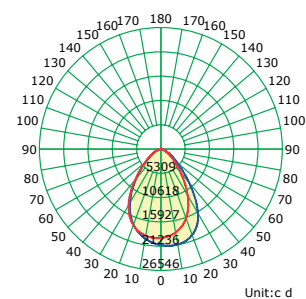

— C0-C180 — C90-C270

Potência 200W | 127V - 220V

Curva de distribuição da intensidade luminosa-Versão 120°

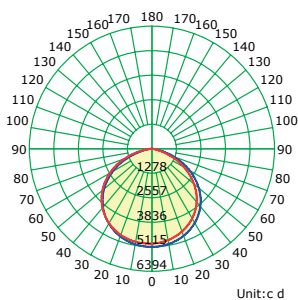

— C0-C180 — C90-C270

Potência 100W | 127V - 220V

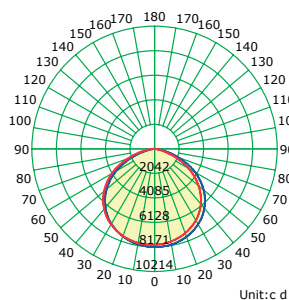

— C0-C180 — C90-C270

Potência 150W | 127V - 220V

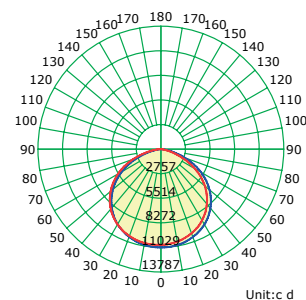

— C0-C180 — C90-C270

Potência 200W | 127V - 220V

*O produto atende aos requisitos L70, LM80 e TM21, publicados pela IESNA (Illuminating Engineering Society North America).

**Estimativa de duração considerando 8 horas de uso diário (2.920h anual), desconsiderando-se fatores depreciativos referentes ao tipo de local instalado.

A garantia inicia-se na data da compra do produto, desde que sejam respeitadas as condições de uso descritas na embalagem, sendo necessário apresentar o Cupom ou a Nota Fiscal.

ATENDIMENTO AO CONSUMIDOR
faleconosco@avantlux.com.br
(11) 3355-2220